

R4000 Series

R4013MG-12M-RGG01E



Features

- Light-integrated design makes red/white/blue illumination optional, support control separately
- Support different focal lengths, electrical auto focus and one-click auto training
- 100M Ethernet interface, IP65 protection level
- Abundant IO interfaces such as Ethernet, RS232, GPIO, support multiple communication protocols
- Support various code formats and evaluations of code quality
- Built-in deep-learning based code reading algorithms and multi-parameters polling to ensure effects of complex applications

Dimensions (mm)

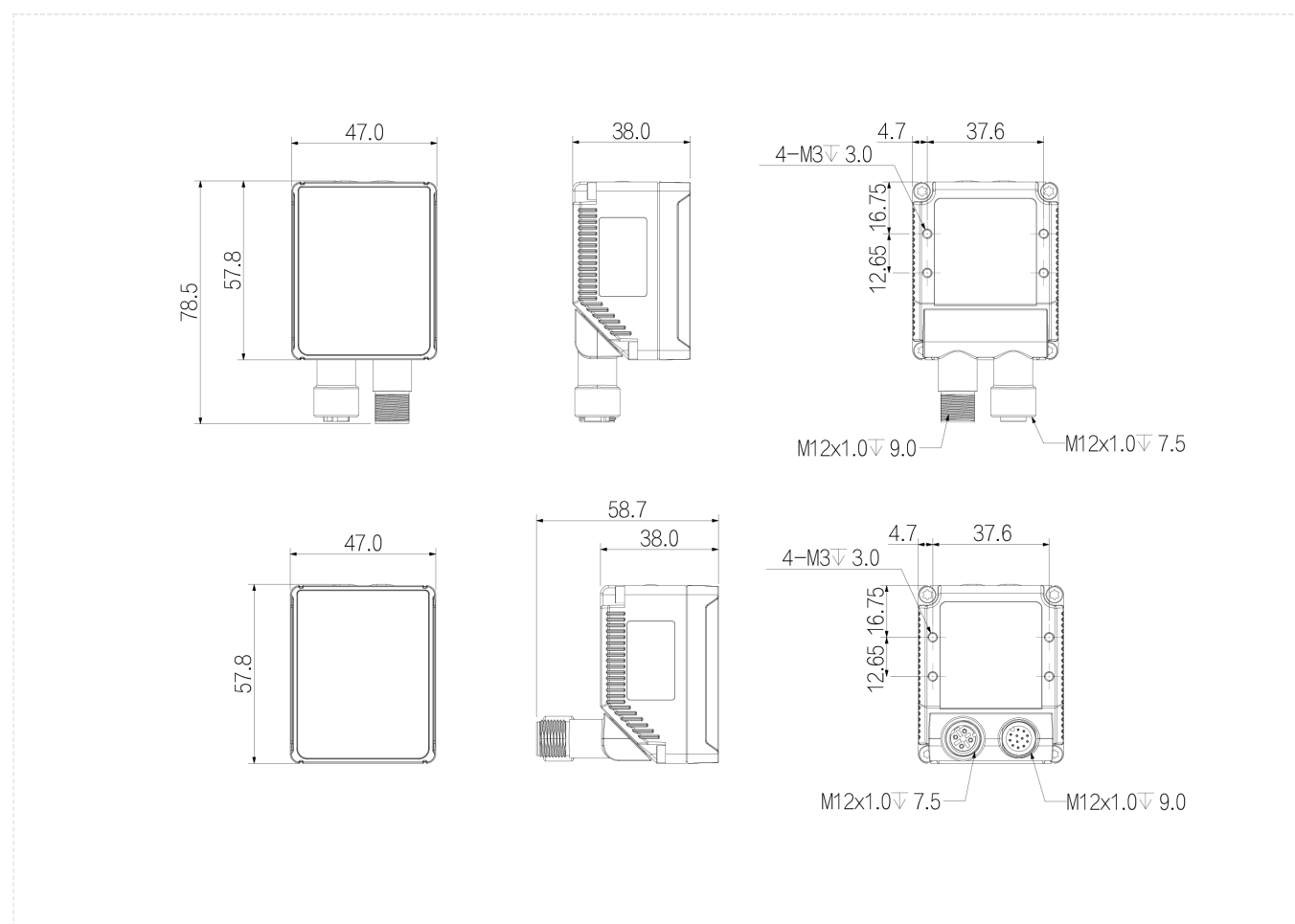













Specification

	Model	R4013MG-12M-RGG01E
Basic	Resolution	1280 × 1024
	Max. Frame rate	60 fps
	Shutter Mode	Global
	Lens Mount	M12, auto focus
	Trigger Mode	Software trigger/External trigger/Free run modes
	Software	EasyID
	Certifications	CE , KC
	Function	ID: Code 39/Code 93/Code128/CodaBar/EAN8/EAN13/UPCA/UPCE/ITF25/2of5 (Industrial2of5) /standard25/GS1-128 etc. and 2D: Data Matrix/MQR/GS1 DM/GS1QR etc.; Quality Evaluation: ISO/IEC 29158(AIM-DPM), ISO/IEC 15415, ISO/IEC 15416)
Performance	Focal Length	12mm
	Working Distance	50-500mm
	Field of View (FOV)	64×51 mm (working distance:150mm)
	Max. Read Speed	60 codes/s
	Light Source Type	Red (Difused/Polarized/Non-polarized)
Port	Connector	2 Industrial connectors support Ethernet and GPIO
	Network Port	100M Ethernet
	GPIO Interface	RS232, 2 Opto-isolated inputs and 3 Opto-isolated outputs
	Communication Mode	RS232, Ethernet
	Communication protocol	SDK,TCP Client,TCP Server,FTP,RS232,Profinet,Modbus,EtherNet/IP,MC(SLMP),FINS/UDP,FINS/TCP
	LED Indicator	Power,Ethernet,Result
Power	Power Supply	9~26V DC, 1.5A input, suitable for industrial environment
	Power Consumption	<5W
Structure	Product Dimensions	47mm×58mm×38mm(not including connector)
	Net Weight	<180 g
	Protection	IP65
	Casing Material	Aluminum alloy + Front cover
Environment	Operating Temperature	-20°C ~ +50°C
	Operating Humidity	20% ~ 95%(no condensation)
	Storage Temperature	-30°C ~ +70°C

Connector Pin-out

12 pin-out on camera:

Pin	Signal	Description	Cable Color
1	OPT_OUT2	Opto-isolated output2	 Brown white
2	RS232_TXD	RS232 serial send	 Grey
3	RS232_RXD	RS232 serial receive	 Purple
4	SIGNAL_GND	RS232 serial GND	 Black white
5	OPT_IN1	Opto-isolated input1	 Yellow
6	OPT_IN_GND	Opto-isolated input GND	 Purple white
7	POWER	Power	 Red
8	POWER_GND	Power GND	 Black
9	OPT_OUT_GND	Opto-isolated output GND	 Green
10	OPT_IN0	Opto-isolated input0	 Orange
11	OPT_OUT0	Opto-isolated output0	 Blue
12	OPT_OUT1	Opto-isolated output1	 Brown
-	-	Shield GND	 White

